

# Meeting tables Ogi W technical specification



.mdd

**.mdd has a leading position among manufacturers of office furniture with many awards that prove quality and continuously increase demand for its products.**

The realities of today's market require constant quality improvement at all levels of modern organization. This applies in particular to customer service, marketing, quality of products and also to quality of processes within the company.

Partnership relations among employees and with business partners form a base of economic growth and success of the company.

Constant investments in innovative machinery park, optimization of management systems and an expansion of production halls allow to minimize the lead times for the product of the highest quality.

**More than twenty years of experience in office furniture industry come with reference from a long list of companies and institutions to show their appreciation for an efficient and comprehensive service. .mdd is highly aware of the environment.**

Being located in the forest region with lake by its side, .mdd takes the nature seriously and invests constantly in a modern and energy-efficient solutions to preserve the local life. Company puts emphasis on waste segregation and recycling. .mdd has been awarded for the exceptional care and involvement in waste disposal. All materials used are environmentally friendly and enjoy a high 95 % rate of being recycled.



## General informations:

### Warranty:

.mdd products - **5 years**.

Electrical components and fabric - **2 years**.

### Certificate - MFC:



### Assembly:

product delivered in separate elements

### Packing:

cartboard, perforated plastic mesh wrap

### Compliant with standards:

PN-EN 15372:2010

### Boards density:

12 mm - 690 - 750 kg/m<sup>3</sup>

18 mm - 650 - 690 kg/m<sup>3</sup>

28 mm - 610 - 630 kg/m<sup>3</sup>

36 mm - 610 - 630 kg/m<sup>3</sup>

**Worktop**

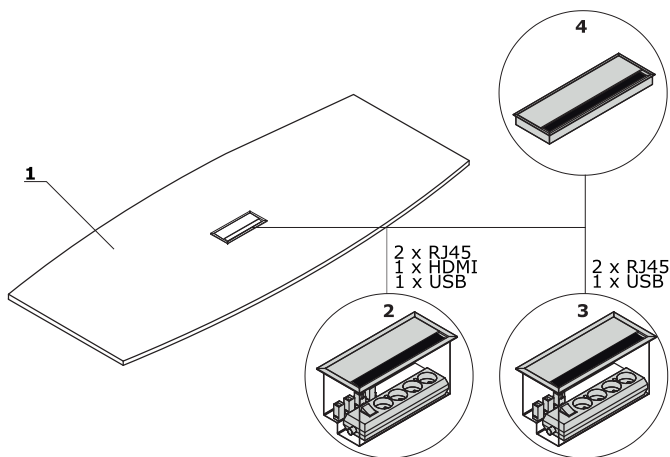

- 1. **Worktop** - MFC 28 mm, ABS edge
- OPTIONS WITH EXTRA CHARGE:**
- 2. **Mediabox M04H** - 2xRJ45 (class E, cat. 6); +1 x USB + 1 x HDMI + 4x 230V, colour: M009 - aluminium semi-matt
- 3. **Mediabox M04** - 2xRJ45 (class E, cat. 6); +1 x USB + 4x 230V, colour: M009 - aluminium semi-matt
- 4. **Top access M05** - colour: M009 - aluminium semi-matt

**Frame - meeting tables Ogi W**

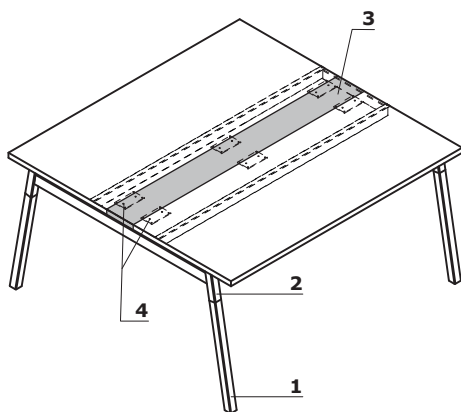

- 1. **Frame** - metal frame , profile 50 × 50 mm, wooden leg - ash natural
- 2. **Metal element** - powder coated
- 3. **MFC element** - matches with frame colour; without mediabox as standard
- 4. **Fixing flat bar**

Conference tables - Ogi W \*

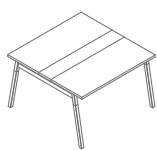

**SW22**  
1200 / 1210 / 740  
48.2 kg

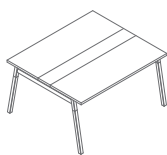

**SW24**  
1400 / 1210 / 740  
55 kg

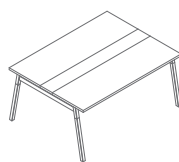

**SW26**  
1600 / 1210 / 740  
59.7 kg

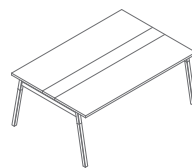

**SW28**  
1800 / 1210 / 740  
67.3 kg

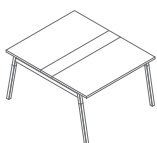

**SW42**  
1200 / 1410 / 740  
56 kg

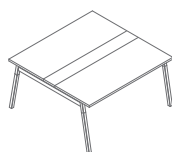

**SW44**  
1400 / 1410 / 740  
65.2 kg

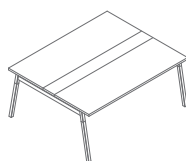

**SW46**  
1600 / 1410 / 740  
69.2 kg

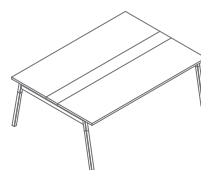

**SW48**  
1800 / 1410 / 740  
75.5 kg

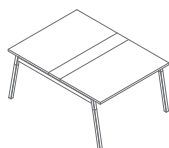

**SW32**  
1200 / 1610 / 740  
63 kg

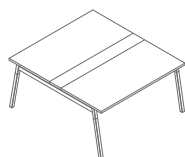

**SW33**  
1400 / 1610 / 740  
69.4 kg

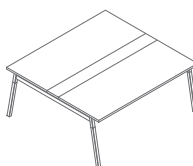

**SW34**  
1600 / 1610 / 740  
77.2 kg

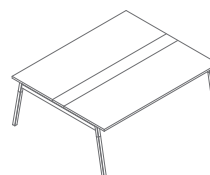

**SW35**  
1800 / 1610 / 740  
83 kg

\* dimensions expressed in millimeters: width x depth x height

Elements for pairing - Ogi W \*



**SW22L**  
1200 / 1210 / 740  
43 kg



**SW24L**  
1400 / 1210 / 740  
49.8 kg

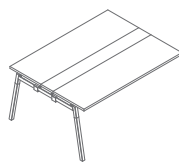

**SW26L**  
1600 / 1210 / 740  
54.5 kg

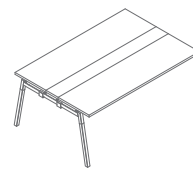

**SW28L**  
1800 / 1210 / 740  
62.1 kg

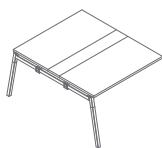

**SW42L**  
1200 / 1410 / 740  
50.2 kg

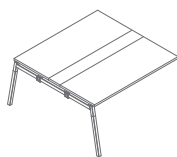

**SW44L**  
1400 / 1410 / 740  
59.4 kg

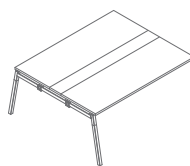

**SW46L**  
1600 / 1410 / 740  
63.4 kg

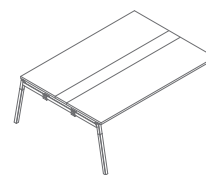

**SW48L**  
1800 / 1410 / 740  
69.7 kg

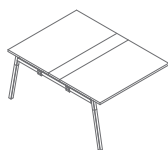

**SW32L**  
1200 / 1610 / 740  
56.8 kg

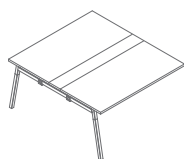

**SW33L**  
1400 / 1610 / 740  
63.2 kg

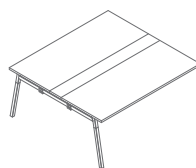

**SW34L**  
1600 / 1610 / 740  
71 kg

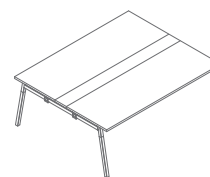

**SW35L**  
1800 / 1610 / 740  
76.8 kg

\* dimensions expressed in millimeters: width x depth x height

Top



08 Black \*



26 Aluminum satinato \*



31 Canadian oak



39 Polar birch



64 Cocoa



67 White pastel \*



106 Lowland walnut



154 Anthracite \*



167 Grey oak



168 Natural oak



169 Honey oak



170 Acacja

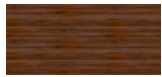

171 Dark walnut

Frame



M009 Aluminum semi-mat RAL9006



M015 White semi-mat RAL9010



M154 Anthracite semi-mat RAL7043



M115 Black semi-mat RAL9005